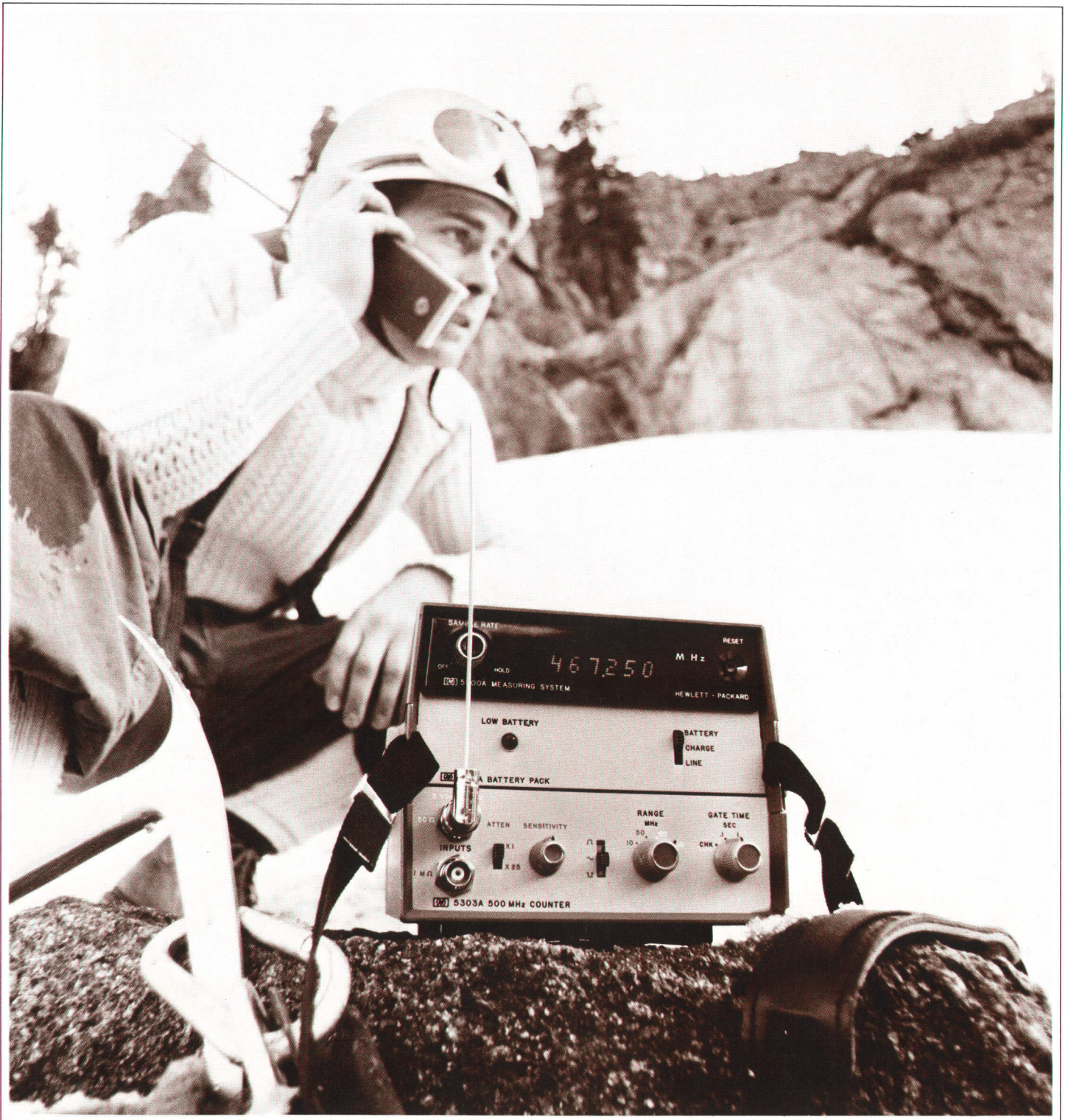


# HEWLETT-PACKARD JOURNAL



AUGUST 1971



# Lilliputian Measuring System Does Much, Costs Little

*A mainframe costing less than \$400, a choice of four functional snap-on modules including a 500-MHz counter, and an unusual battery pack are the elements of this rugged, portable, MOS/LSI/LED instrument system.*

**By Ian T. Band, Hans J. Jekat, and Eric E. May**

NOT VERY MANY YEARS AGO electronic counters were strictly laboratory instruments. Nobody needed their kind of precision in frequency and time measurements anywhere else. Today, however, what used to be laboratory precision is now commonplace in all kinds of equipment, and as a result electronic counters are in demand as general-purpose service and maintenance tools.

One only has to look at the communications industry to see what's happened. The crowded electromagnetic spectrum has been squeezed to make room for more and more channels. To guarantee that each transmitter remains within its allocated channel, its frequency must be controlled to within a few parts per million. Measuring frequency with this degree of accuracy requires an electronic counter. Or look at the vast network of telephone cable and equipment, over which millions of messages are transmitted daily. To keep it in working order, carrier frequencies must be measured and calibrated. Tone bursts must be counted. Millions of relays must be checked and timed. These are jobs for electronic counters.

The kind of counter that's needed for service and maintenance is quite different from the usual laboratory type. It has to be simple, rugged, and reliable. It has to be portable—even battery powered—since the equipment to be serviced is likely to be a communications link on a distant hilltop or the navigational equipment aboard a ship. It has to be low enough in cost to be considered a general service tool. And it has to have sufficient measurement capability to fill the majority of service and test needs.

## **Mini-System**

Hewlett-Packard's answer to these requirements, the 5300 Measuring System, is equally at home on the lab

bench or in a maintenance van. Calling it a system may seem a bit pretentious, since it's the smallest of HP's counters. Yet its modular design gives it versatility and a repertoire of measurement capabilities that many full-size instruments don't have, including frequency measurements to 500 MHz, 100 nanosecond time-interval resolution, autoranging, and battery operation. The 5300 system is one of the first of the new breed of instruments that rely heavily on the newer technologies: MOS, large-scale integration, solid-state light-emitting-diode displays, high-speed bipolar integrated circuits, read-only memo-



**Cover:** You probably wouldn't find a 5300 Measuring System among a mountain rescue team's standard equipment. But one could be used at the base camp for checking vital radio equipment. Shown here is all it takes: a 5300A mainframe, a 5310A battery pack, a 5303A 500 MHz counter module, and a makeshift antenna.

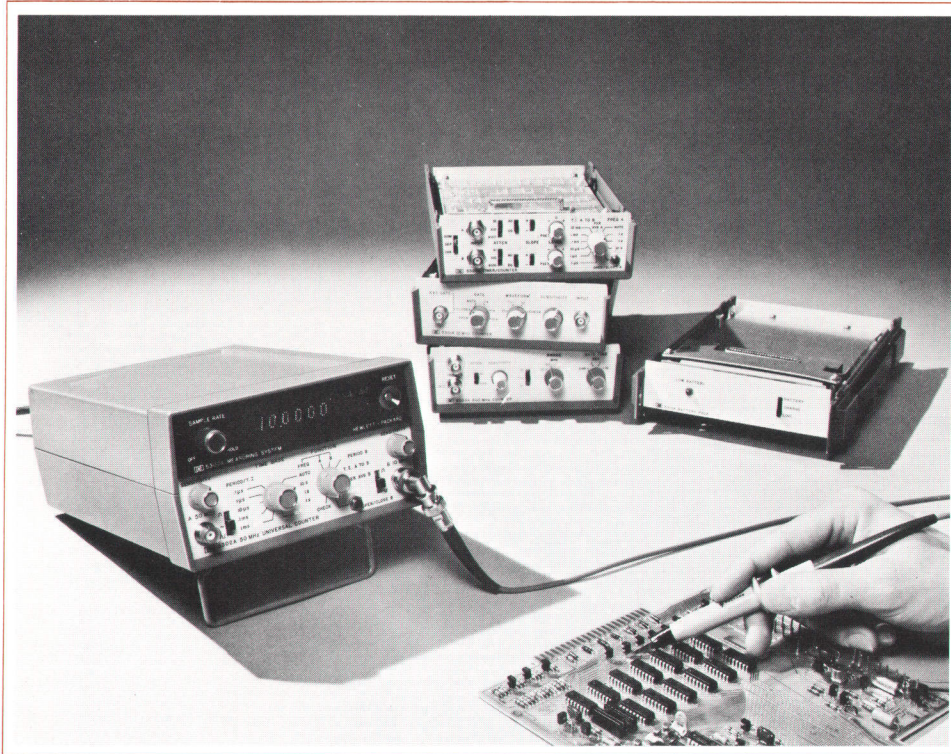
## ***In this Issue:***

*Lilliputian Measuring System Does Much, Costs Little, by Ian T. Band, Hans J. Jekat, and Eric E. May . . . . . page 2*

*A Package for Portability and Serviceability . . . . . page 9*

*An Almost All Solid-State Strip-Chart Recorder, by Charles K. Michener . . . . . page 13*





**Fig. 1.** Compact, low-cost 5300 Measuring System consists of a mainframe (top half of instrument at left), four snap-on functional modules, and a battery pack (right). Autoranging, serial BCD digital output, and a high-stability crystal reference oscillator are standard.

ries, and thin-film hybrid circuits. From the combined advantages of all these technologies this mini-system derives a level of performance that couldn't have been achieved at such low cost just a few years ago.

Modular design is apparent in the system photograph, Fig. 1. The heart of the system is a six-digit counter mainframe, Model 5300A, which can be combined with any of several functional modules to meet specific application needs. The first four functional modules are now available (see table, page 4). There's a low-cost 10 MHz autoranging counter (Model 5301A), a wideband 500 MHz counter (Model 5303A), a 50 MHz general-purpose universal counter (Model 5302A), and a precision timer-counter specifically optimized for timing measurements (Model 5304A). Any combination of mainframe and module can be instantly adapted for battery operation by inserting a rechargeable battery pack (Model 5310A).

The benefits of modular construction are considerable. Modularity makes it possible to choose from a wide range of measurement functions, but to have at any one time only those functions necessary to do the job, without the extra cost, complexity, and power consumption (in this case, battery drain) of unused functions. If and when a need arises, new capability can easily be added to the system by adding more functional modules. Adding these only when they are needed assures the user of always

having the latest in measurement capabilities at minimum cost. Another economic advantage is that the mainframe can be produced in relatively high volume, thereby bringing its cost down.

#### **The Mainframe**

The mainframe of the 5300 system is the upper half of the instrument. All the elements necessary for a complete 10-MHz six-digit counter are contained in this main module. It houses the solid-state display for the system, all the basic counting, storing, and timing logic, a high-stability 10 MHz crystal-controlled reference oscillator, and all the functional control logic for precision counting and timing. All the power for the system is provided by the high-efficiency switching power supply in the mainframe.

By itself, the mainframe can perform no measurements. The bottom half of the instrument, the snap-on functional module, calls upon the mainframe's capabilities as needed for the particular application. This partitioning of capabilities maximizes the flexibility of the system. In the simplest case, the 10 MHz counter, the snap-on module consists merely of an input amplifier and trigger circuit to convert a low-level input signal to a good logic-level signal for the mainframe, plus a hard-wired program to tell the mainframe what to do with the signal.



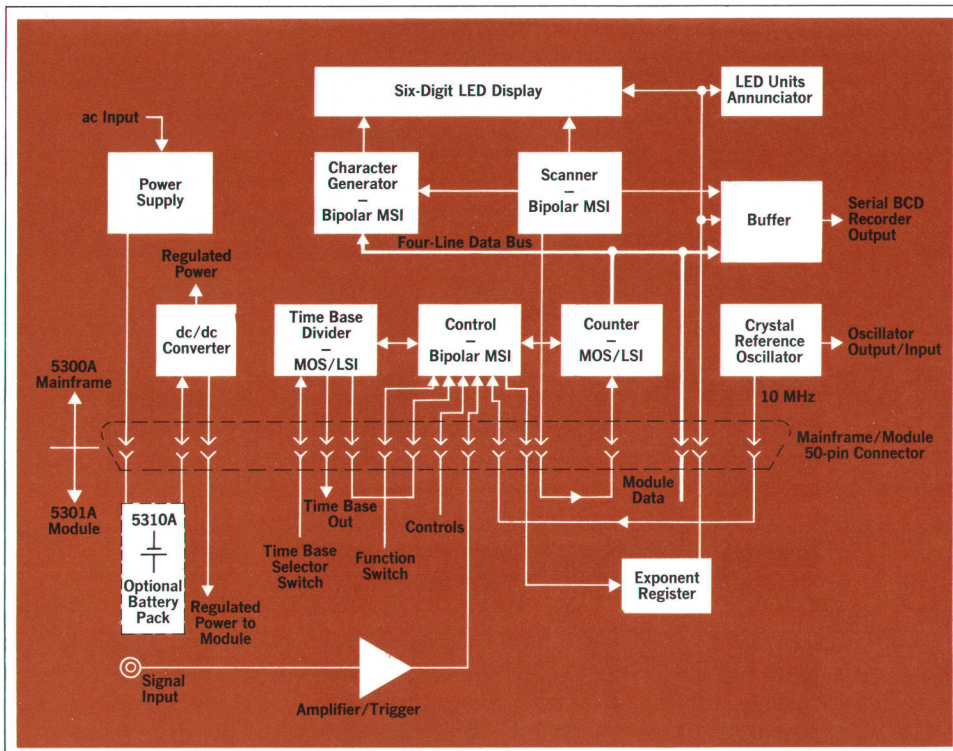
## The 5300 System

5300A MAINFRAME FOR USE WITH ALL MODULES								\$395
5310A BATTERY PACK FOR USE WITH ALL MODULES								\$175
MODULES	FREQUENCY			TIME INTERVAL	PERIOD	PERIOD AVERAGE	TOTALIZE	RATIO
	10 MHz	50 MHz	500 MHz					
5301A	✓						✓	\$125
5302A	✓	✓		✓	✓	✓	✓	\$250
5303A	✓	✓	✓					\$750
5304A	✓			TRIGGER			✓	\$300
				CONTROLS				

### System Architecture

The 5300 is designed as a system from the ground up. The system approach is evident in the architecture of the mainframe. The block diagram, Fig. 2, shows the mainframe coupled to a typical snap-on module. All data is transmitted one digit at a time (digit serial) on a four-line data bus. Data can be moved from the mainframe to the module and vice versa and from either location to the front-panel display and to the rear-panel recorder output. The flow of data is controlled by a set of address codes which can be manipulated by the snap-on module. Coded signals are also used to program the output frequencies from the time base.

In a low-cost counter, this bus-oriented architecture represents a radical departure from the past. It's significant that the basic block diagram of a counter has remained relatively unchanged for the last ten years, surviving the major upheavals of technology from vacuum tubes to transistors to medium-scale-integrated circuits. Now, however, with the advent of large-scale-integrated (LSI) circuits, a break from tradition seems overdue. When a few dozen extra transistors become insignificant compared with the cost of a few extra pins on an IC package, design rules can easily be changed. In the 5300 system the change was towards a greater emphasis on signal multiplexing and automatic operation.



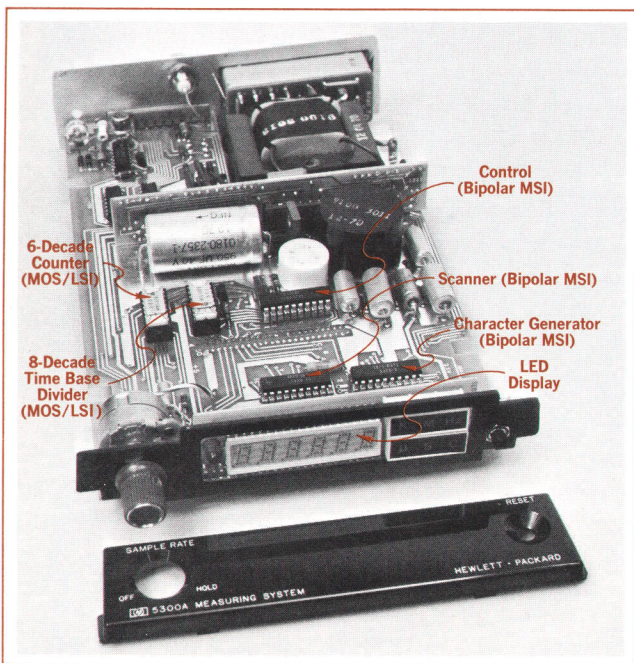
**Fig. 2.** Systems design results in a block diagram that's different from other counters. All data is transmitted one digit at a time on a four-line data bus. The snap-on module determines the function of the instrument.



The system approach resulted in reduction of all the counter logic to a simple combination of only five integrated-circuit packages (see Fig. 3), corresponding to the five basic blocks of the block diagram, Fig. 2. Inside each of these packages, however, is a very complex array of circuitry.

### The LSI Circuits

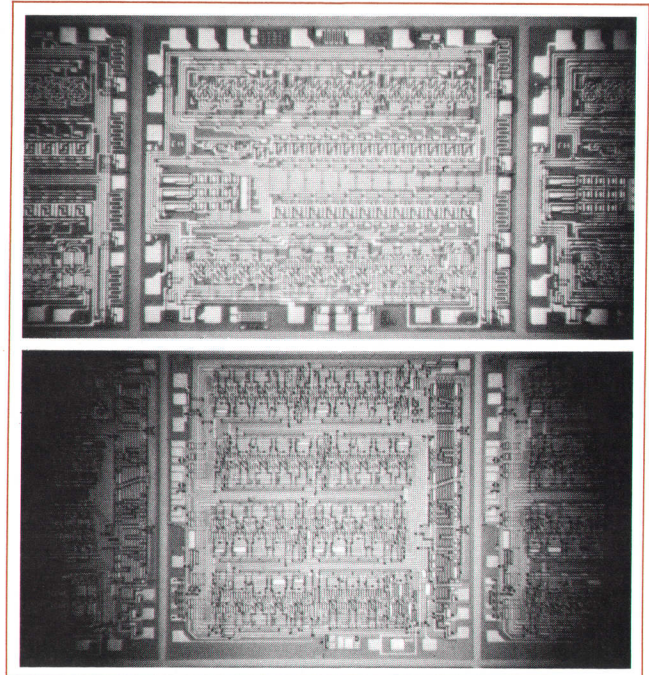
Two of these packages in particular represent a significant advance in IC technology. The counting circuitry and the time-base dividers have always imposed a limitation on any counter-based instrument in terms of performance, cost, size, and power drain. In the 5300 system, two small 16-pin packages containing MOS/LSI chips have replaced what was previously half of the instrument.



**Fig. 3.** Mainframe contains a complete six-digit 10 MHz electronic counter except for an input amplifier and trigger. Large-scale and medium-scale integration and a solid-state display reduce the six major blocks in Fig. 2 to just six components. Benefits are reliability, serviceability, and low power consumption.

A six-digit counter like the 5300A requires a six-decade counting circuit and six decades of data storage. The most common way of implementing such a circuit today would be with twelve TTL integrated-circuit packages. However, in the 5300A all six counting decades and six storage registers are on a single integrated-circuit chip in a 16-pin ceramic package. This metal-oxide-semiconductor (MOS) large-scale-integrated (LSI) cir-

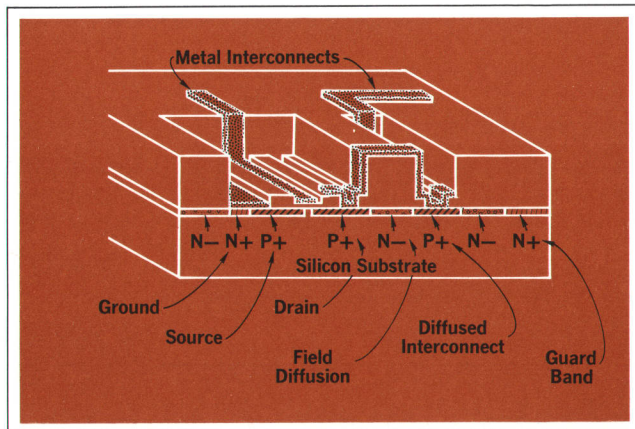
cuit is capable of counting rates in excess of 10 MHz. The chip measures 96 mils by 118 mils (Fig. 4). It contains 930 transistors, but consumes only 300 mW. It's an excellent example of the advantages of MOS/LSI over bipolar IC's: lower package count, lower power consumption, and fewer interconnections to cause reliability problems.



**Fig. 4.** 10 MHz MOS/LSI six-digit counter circuit and eight-decade time base chips. Counter chip (top) is 0.096 in by 0.118 in and contains 930 transistors. Time base is 0.109 in square and contains 980 transistors.

The MOS process used by HP is low-threshold p-channel MOS. 10 MHz speeds had never been achieved with this process before the six-decade counter chip was developed. The high speed comes from a combination of factors.<sup>1</sup> First, the transistors in each of the six decades are made only as large as necessary for the counting rate at which they had to operate. Only the first binary of the first decade actually has to operate at 10 MHz. Second, geometries are reduced to minimize capacitance. Channel lengths are 2.5  $\mu\text{m}$  after side diffusion and gate metal overlap is 1.25  $\mu\text{m}$  before diffusion. Third, the need for interconnecting metallization is minimized by a unique 'ground riveting' process (see Fig. 5). What this technique does is eliminate all unnecessary ground lines to the sources of the MOS transistors. An N+ region is diffused next to the P+ source diffusion and the two diffusions are connected by metal. This connects the source to the substrate, the other side of which is con-





**Fig. 5.** Extra N+ diffusion next to P+ source, and extra N+ guard band, are elements of a unique 'ground riveting' scheme that was used to eliminate much ground metallization. This reduced the sizes of the MOS chips and allowed 10 MHz speeds.

nected to the case, which is grounded. A source riveted in this manner is not actually grounded. However, it's separated from ground only by the series resistance of the source pad. To reduce this series resistance a guard band of N+ material is diffused around the entire chip. This reduces the series source resistance to approximately 800 ohms per square mil. A load-to-source resistance ratio of 100 to 1 is used to assure sufficient noise rejection and the sizes of the source pads are adjusted accordingly. Using the riveting method throughout the circuit, the design engineer for all practical purposes has the freedom to forget ground lines. He no longer has to provide space for them. This, of course, reduces the size of the chip and increases the speed. Direct counting rates of 12.5 to 20 MHz are consistently achieved.

In a typical six-decade counter with digit-parallel binary-coded-decimal readout there are 24 outputs to the display driver. This is too many for a compact package, so in the 5300A a strobed readout is used: the digits are read out one at a time on the same four lines. Three input lines control the digit to be read out and the timing of the readout. Thus the 24 lines are reduced to seven.

The time-base divider in the 5300A is also a single MOS/LSI chip measuring 109 mils square and containing 980 transistors (see Fig. 4). It also operates at 10 MHz, consistent with the 5300A's 10 MHz crystal oscillator. The time base chip has eight decades; thus it can divide the 10 MHz crystal oscillator frequency by as much as 100 million, to provide gate intervals as long as 10 seconds.

To reduce the pin count and take advantage of the LSI technology, the architecture of the time base was

changed from the traditional divider chain. One change is that the time-base output frequency is selected on the chip and is programmed by a three-wire select code to divide the time-base input frequency by any decade factor from 10 to  $10^8$ . However, the major distinction from all previous counting instruments is the second time-base output which produces a logarithmic train of pulses. This is the key to the autoranging feature of the instrument.

### Autoranging

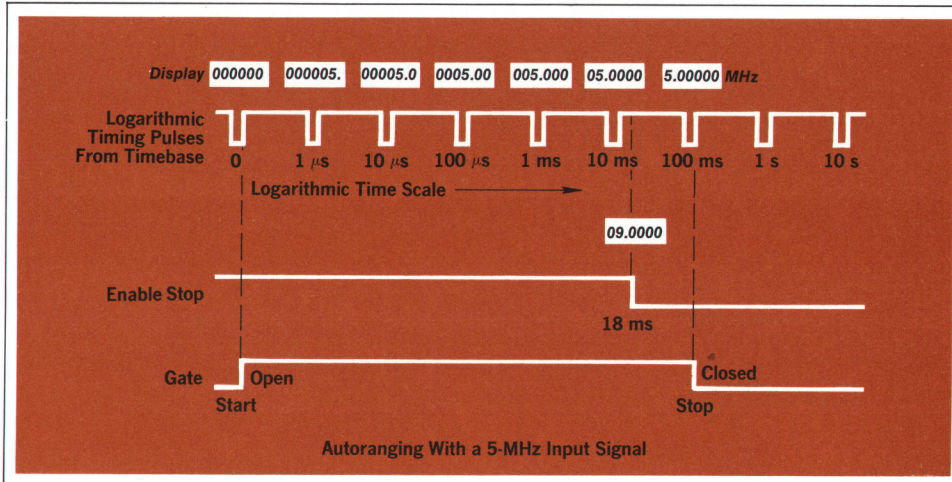
One of the major features built into the LSI circuits is the capability of making measurements automatically, so the operator doesn't have to change ranges. Autoranging, which is built into the mainframe, allows the display to be filled for maximum resolution, but prevents the display from overflowing. In the case of a frequency measurement, this means automatically selecting the optimum gate time. For a period-average measurement, the optimum number of periods to be averaged is selected. In either case the decimal point is positioned automatically and the correct measurement units are displayed. Three of the four snap-on modules make use of this feature to simplify the function controls and provide foolproof hands-off operation.

Let's take a simple example (see Fig. 6). A frequency of 5 MHz is to be measured in the auto mode. As the measurement proceeds, cycles of the 5 MHz signal are accumulated in the counting circuits. The measurement will be terminated after a precise measurement time—for example, one second—to give a total count that can be interpreted as cycles per second or hertz. The measurement time is determined by the time base. In one second, however, the 5 MHz signal would overflow the capacity of the six-digit display; therefore, a shorter measurement time must be selected. In this case, a 0.1 second gate time would give an accurate six-digit count of 5.00000 MHz. Any shorter gate time, such as 0.01 second, would give a valid reading but would not completely fill the display.

As the measurement progresses, the autoranging circuits detect when the first five digits of the display have been filled, or more exactly, when a count of 90,000 is reached. In the case of the 5 MHz signal, this would be after 0.018 second. The next valid measurement time is then selected, in this case, 0.1 second. The measurement time is always restricted to decade steps.

The MOS time base provides all the necessary timing signals beginning with a start pulse to initiate the measurement. This is followed by a succession of valid stop pulses at decade intervals of 1  $\mu$ s, 10  $\mu$ s, 100  $\mu$ s, and so





**Fig. 6.** Autoranging selects the gate time for maximum resolution without overflowing the display. A logarithmic output from the time-base chip produces pulses at decade multiples of 1  $\mu$ s. The counter counts until the fifth decade reaches a count of 9, then terminates the measurement on the next logarithmic pulse. Manually-selected gate times are also available.

on up to 10 seconds. Every stop pulse is precisely timed in relation to the same start pulse. All these timing signals are generated at a single output terminal of the time base and are synchronized with the clock frequency so that propagation-delay errors are cancelled. Since all possible stop pulses are available on a single line, it's a simple matter for the autoranging control circuits to select the first available stop pulse following the 90,000 count. To position the decimal point and units correctly, the measurement range is determined by counting the number of stop pulses which occurred before the display was filled. In the event that the frequency is too low to fill the display in a reasonable time, an arbitrary limit of one second is set on the measurement time. (Longer gate times can be selected manually.)

### Let There Be (Solid-State) Light

The display of the 5300 system is another departure from the past. A light-emitting-diode (LED) display was chosen as a step towards all-solid-state reliability. Low voltage drive, low power drain, and an in-plane wide-viewing-angle display were other benefits of the LED approach.

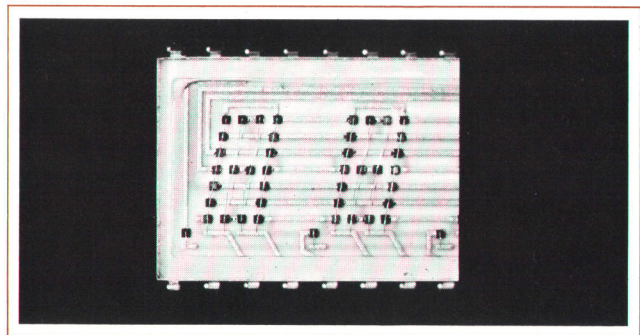
Each digit of the display is formed by a 4 x 7 matrix of red-light-emitting gallium-arsenide-phosphide (GaAsP) diodes (Fig. 7). Characters of this type have more esthetic appeal than the simpler and more common seven-segment type of display. An added advantage of the dot-matrix approach is redundancy: if a failure occurs in any one diode, the character cannot be misinterpreted as a different digit. The 5300 display contains all six 4 x 7 arrays on a single ceramic substrate.

In keeping with the one-digit-at-a-time data transfer in the instrument, the display is scanned rather than continuously lighted, only half a digit being lit at any time.

However, the entire display is scanned 1,000 times every second so the display appears steady. Since each diode can be on for only 1/12 of the total time, its instantaneous brightness must be 12 times higher than a static display. This turns out to be an advantage with LED's since the gallium-arsenide-phosphide diodes have a higher efficiency at high currents. Thus although the peak current is high, the average current and power required are less than would be needed for a static display of the same brightness. The power saving is particularly important when the battery pack is being used.

### Measuring Frequencies to 500 MHz

Although the 5300A mainframe can count only to 10 MHz, the snap-on modules can greatly extend this range. The upper frequency limit at present is 500 MHz and is reached by adding the 5303A module. The 5303A pre-scales the 500-MHz input signal; that is, it divides the input frequency until it is within range of the 10-MHz mainframe counting logic.



**Fig. 7.** Data comes out of the counter chip one digit at a time, so the solid-state display is scanned instead of continuously lighted. One-half digit is lighted at a time. A scan is completed every millisecond, so the display appears steady.



To extend the counting capabilities up to 500 MHz several new circuits had to be developed in HP's integrated circuit labs. The input signal is amplified by a thin-film hybrid amplifier and trigger circuit. A monolithic 500 MHz binary and a 250 MHz quinary ( $\div 5$ ) divide the frequency down to a manageable 50 MHz. These two high-speed monolithic circuits are special EECL (emitter-emitter coupled logic) circuits with two-layer metallization.<sup>2</sup>

In a six-digit counter, the effect of prescaling on measurement accuracy is negligible. Prescaling can sometimes be an advantage for measuring frequency-modulated signals. To fill all six digits in a direct-count measurement, a 500-MHz carrier frequency can be measured to six-digit accuracy in 1 ms with 1 kHz resolution. The same measurement with the 5303A takes 100 ms, since the input is first divided by 100. But people don't respond to changes in the display much faster than 10 times per second, so the difference in the number of readings per second is undetectable, and the longer measurement time allows the errors due to frequency modulation of the carrier to be averaged out.

A typical application of the 5303A would be calibration of a mobile transmitter at frequencies just below 500 MHz. These transmitter frequencies must be maintained within an accuracy of 5 parts per million, which would be about 2.5 kHz maximum error. To measure the transmitter frequency the 5300A/5303A can be placed a few yards away from the transmitting antenna with just a small vertical whip antenna connected to its BNC input terminal. The 0.1 s range can be used for a rapid but coarse adjustment to  $\pm 1$  kHz. A finer adjustment can be made by allowing the most significant digit of the display to overflow in a 1 or 10 second measurement, giving a resolution of 100 Hz or 10 Hz. Other measurement ranges allow resolutions down to 1 Hz for frequencies below 50 MHz—which are prescaled by only 10—and 0.1 Hz below 10 MHz, where frequencies are directly counted.

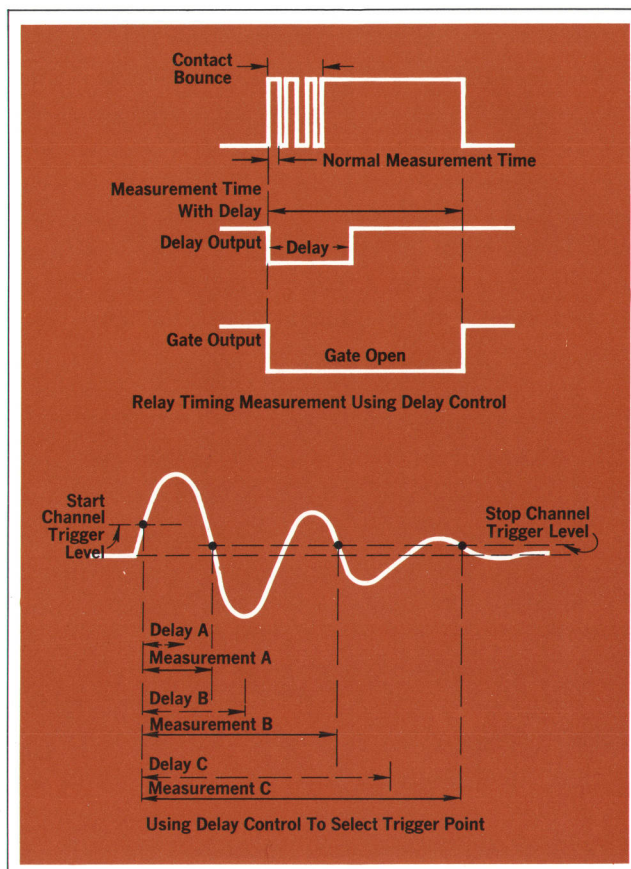
### Making Precision Time Measurements

As well as measuring a wide range of frequencies, the 5300 system can measure time intervals between events or between different parts of a signal. The 5302A snap-on module can measure time with 100 ns resolution. Its normal range is up to 1,000 seconds, although it can be used to time events as long as 10 million seconds (four months) to 10 second resolution by proper interpretation of the display.

The 5302A is perfectly adequate for most timing mea-

surements, but it is limited to measurements between the leading edges of two *different* signals. Its two input amplifiers are ac coupled. For better precision in timing measurements, the 5304A module is more useful. It can measure time between any two points on the same signal, and it can select the precise voltage at which triggering occurs, on the leading edge or the trailing edge of positive or negative signals. Its two matched dc-coupled input amplifiers have bandwidths of 0–10 MHz; they can also be ac coupled for measurements of signals with large dc offsets. In addition to timing events, the 5304A can make measurements of pulse widths, rise times, and other intervals between precise points on a waveform.

And that's not all. Besides selecting the exact trigger point on an input waveform the 5304A can select which section of a waveform will trigger the stop channel. This is the function of its delay control, which allows it to perform measurements that are beyond the capabilities of most other timer-counters.



**Fig. 8.** Model 5304A Timer/Counter snap-on module is optimized for time-interval measurements. It has 100-ns resolution and an unusual delay feature which causes the counter to ignore extraneous events and measure the interval of interest. Delay is useful for relay timing and tone-burst measurements.



## A Package for Portability and Serviceability

The packaging of the 5300 system is a good example of today's demands on human engineering and industrial design. The package had to be rugged, portable and serviceable, as well as have high performance and low cost. The approach taken features a cast aluminum case for ruggedness and RFI shielding\*, snap-on modules rather than plug-ins, and snap-together assembly for serviceability without a screwdriver. The units are portable, stackable, and rack-panel mountable.

The snap-on concept was used for several reasons. First, there is no repackaging. A normal plug-in unit requires its own package which then must be insertable into a mainframe package. In the 5300 system, the snap-on module is simply a bottom half identical to the mainframe top half, and together the two make up one complete package. In addition, there can be an in-between module, like the battery pack, which fits between the mainframe and the snap-on module. In concept, the counter could be expanded indefinitely with a whole series of center modules. Another advantage is that each snap-on and in-between module has its own rear panel which can change depending on its function.

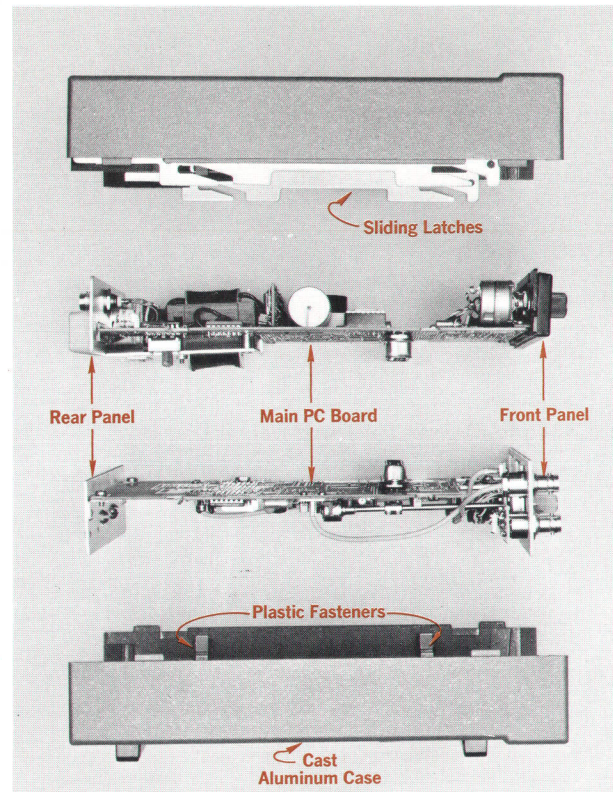
The package consists of two half-shells which snap together with two integral sliding latches. The shell serves not only as a covering but as a chassis and RFI shield, since it is made of cast aluminum. There is no sheet-metal chassis as such; the extensive use of LSI circuits and IC packages has made it possible to put all the circuitry in each module and the mainframe on one main PC board. The PC board and the front- and rear-panel assemblies snap into a set of plastic clips in the casting. This allows instant assembly or disassembly for servicing.

The case is designed for portability. It is small and shaped so it can be carried readily in one hand. This makes it easy to move around a bench; there's no bothersome handle to fold out of the way. Other units can be stacked on the case. A tilt stand attached to the front feet is useful for normal bench viewing, or it can be attached to the rear feet for easy viewing when the counter is placed on top of a cabinet or shelf.

For complete portability the power cord is disconnected and the battery pack is added between the mainframe and its functional snap-on module. There are handles on the sides of the battery pack, and there's a shoulder strap for

carrying the counter or for draping it around one's neck for hands-free operation. The rear of the instrument has no protrusions, so it can stand on end while on battery power.

Vacuum-formed dust covers are provided with each snap-on module to protect them and allow easy stacking when not in use. Although designed for bench use and portable operation the counter can be rack mounted in a standard 19 in rack panel, or mounted as a 1/2 module in a combining case.



\*The cast aluminum case is a far better shield than most instrument cases. By itself, however, it isn't a complete RFI shield. Complete RFI shielding of the 5300A would require a metal screen behind the plastic front panel of the mainframe.

### Making Delayed Timing Measurements

The front-panel delay knob controls a time delay which begins at the instant the start channel is triggered. Until the time delay has expired, the stop channel cannot be triggered. This allows the end point of the measurement to be selected in much the same way as the delayed sweep on an oscilloscope allows a selected portion of a signal to be displayed.

The delayed time-interval capability is particularly useful for relay timing measurements, in which relay contact bounce usually imposes a measurement problem (see

Fig. 8). Instead of measuring the correct time during which the relay is closed, most timer-counters would measure only the duration of the first bounce, terminating the measurement when the signal first passes through the trigger voltage selected for the stop channel. With the 5304A, however, the contact bounce can be ignored by adjusting the delay to be longer than the bounce period. Thus the true time interval until the contacts are opened again can be measured. The bounce time can also be measured, by increasing the delay slowly and measuring the time to each bounce. A delay output and a gate out-



put, available at rear-panel connectors, can be used to intensity-modulate an oscilloscope to show the exact internal being measured. Similarly, the duration of a tone burst can be measured by beginning with a long delay and decreasing it until the stop channel is triggered by the last cycle in the burst.

The delay time itself can also be measured precisely in the check mode. This provides a convenient way of using the 5304A as a digitally calibrated delay generator, since the delay output is available at a rear-panel BNC connector.

### Printing Out the Data: Parallel Optional

Data being measured by the 5300 system can easily be recorded on a digital printer like the HP 5055A, or accepted by a computer. A standard rear-panel data output sends out the buffered information in a digit-serial bit-parallel binary-coded-decimal format. The output is synchronized with the scanning of the display. Conversion to an optional parallel format is provided by an accessory cable, Model 10533A. The serial-to-parallel converter circuitry is in a small plastic housing at the remote end of the cable (Fig. 9). Two advantages of this method are the lightweight flexible cable with only a few conductors, and a wide range of possible formats to which the serial data can be converted.

A feature of the data output is the floating decimal point which is time-multiplexed with the serial data and printed out in the correct position. On all HP printers the decimal point is printed out as an asterisk (Fig. 9). Measurement units are printed as a true exponent (for example,  $\mu\text{s}$  is printed as  $-6$ ).



Fig. 9. Serial-to-parallel converter at end of accessory cable converts BCD output of 5300A mainframe to parallel form required by many printers.

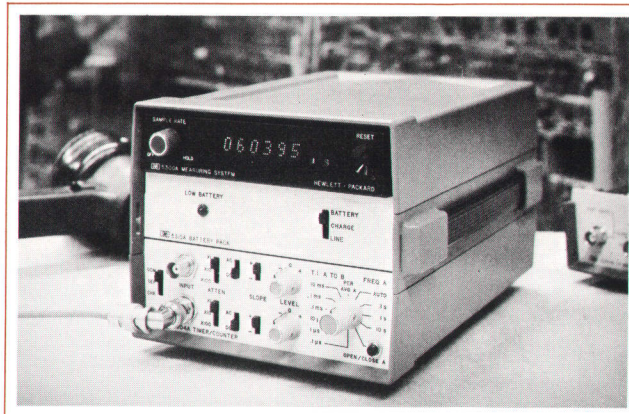


Fig. 10. Battery pack fits between mainframe and snap-on module. It has handles and a detachable shoulder strap.

### Portable Power

Not only can the 5300 system go anywhere the user goes, but it can take its own power, too. Model 5310A battery pack can power the system for up to eight hours without recharging. This is essential for calibrating mobile equipment where extra power isn't available, where ground-loop currents may cause false counts, or for awkward spots such as the top of a high rack of equipment which is just a little too far away from the nearest power outlet for convenience.

The battery pack (Fig. 10) is unusual in that it fits between the mainframe and the snap-on module like the meat in a sandwich. It thus becomes an integral part of the construction instead of an awkward appendage. This also puts the large mass of the batteries in the middle so when the instrument is carried by the handles or the shoulder strap which are provided with the battery pack, the package is well balanced.

Power to recharge the battery pack comes from the mainframe power supply. The requirements on this supply are quite severe. Although the total power drain is usually only a few watts, the tiny power supply in the mainframe has to be capable of powering many snap-on modules with widely differing load requirements and of providing power to recharge the battery pack. It has to operate from a wide range of ac power inputs or from the dc battery. The power supply is therefore in two sections, an ac transformer input which provides an intermediate dc voltage, and a high-efficiency, high-frequency dc-to-dc converter. An automatic SCR shutdown protects the supply and the circuits against overvoltages.

### Safe, Reliable, and Serviceable

When the mainframe is separated from the other mod-

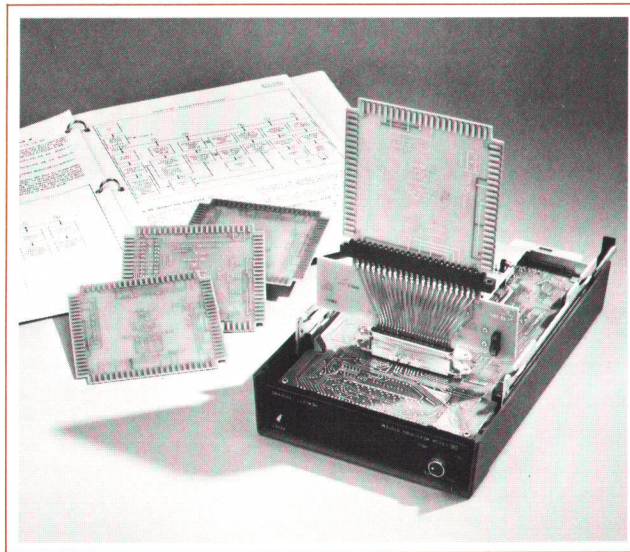


ules, an interlock circuit automatically shuts off the power to all exposed circuits. This is one of the many safety features built into the instrument. Another is the power line input: the line voltage cannot be changed without first removing the line cord and the fuse.

Reliability is emphasized by the use of all solid state components, a minimum number of parts, and low power levels in all the circuits. However, in the event that a failure occurs, serviceability has been considered in the use of sockets for all major IC and display modules.

### Diagnostics

Finding the problem in a 5300 which is not working correctly is easy using the diagnostic kit (Fig. 11). This kit contains a set of simple PC cards and an interface connector which plugs onto the 5300A mainframe. A set of diagnostic routines which are built into the mainframe circuits can be exercised by programming the mainframe from the PC cards. Each card programs four tests; these are called upon by plugging the card into the connector on each of its four edges in turn. For example, test 5 on card B makes a self-check frequency measurement on the counter's own 10-MHz oscillator. Test 4 checks out the display by slowly cycling the numbers 0 through 9 in all six digits of the display. A step-by-step diagnostic routine, using only these four cards and the troubleshooting trees in the service manual, can usually pinpoint the trouble down to the individual components without even opening up the mainframe. If the mainframe checks out correctly, it is then used to diagnose trouble in the snap-on module.



**Fig. 11.** Diagnostic kit, an accessory, quickly pinpoints faults in 5300A mainframe.

### Eric E. May



Rick May was responsible for the mechanical design of the 5300 system, from initial concepts to production. He joined HP in 1969, soon after receiving his B.S. degree in mechanical engineering from the University of Massachusetts. A native of the New England area, Rick says he came west because he enjoys 'California weather and attitudes.' Weather definitely plays a role in his major leisure-time activities: he likes camping, tennis, and skiing.

### Hans J. Jekat



Hans Jekat holds the equivalent of a B.S. degree from a technical school in Munich. After moving to the USA in 1958 he designed mobile telephone equipment for four years, then switched to linear integrated-circuit development. He joined HP in 1964 to work in counter design, but his last few years have been occupied with developing the MOS/LSI circuits that made the 5300 system possible. Hans has several patents and a professional paper to his credit. He recently built his own home, and he has a rather unusual avocation — training show horses.

### Ian T. Band



Ian Band is project manager for the 5300 system. A native of Scotland, Ian received B.Sc. and B.Sc. Honours degrees in physics from the University of St. Andrews in 1957 and 1958. He came to the United States in 1963 and joined HP in 1965 to take charge of the first HP integrated-circuit design section. After designing many special IC's for several HP counters, it was a logical step for him to begin designing complete counters and counter systems. Ian holds several patents and has authored two previous Hewlett-Packard Journal articles. He's a skier, and he owns and races a 420 sailboat.



## SPECIFICATIONS

### HP Model 5300A Measuring System Mainframe

**TIME BASE**  
CRYSTAL FREQUENCY: 10 MHz.  
STABILITY:  
AGING RATE: <3 parts in 10<sup>7</sup>/mo.  
TEMPERATURE: <±5 parts in 10<sup>6</sup>, 0° to 50°C.  
LINE VOLTAGE: <±1 part in 10<sup>7</sup> for 10% line variations.

**GENERAL**  
DISPLAY: 6-digit solid state LED display.  
DISPLAY STORAGE: Holds reading between samples.  
RESET: Front panel pushbutton switch.  
OPERATING TEMPERATURE: 0° to 50°C.

**POWER REQUIREMENTS:** 115 or 230 volts ±10%, 50 to 400 Hz, 25 VA maximum (depends on snap-on module). Mainframe power without snap-on nominally 5 watts. Battery operation with 5310A rechargeable battery pack.

**DIGITAL OUTPUT:** Digit-serial, 4-bit parallel BCD available at rear panel connector.  
CODE: 4-line 1-2-4-8 BCD, '1' state low, TTL logic levels.  
HOLDOFF: Contact closure to ground or TTL low level, inhibits start of new measurement cycle.  
PARALLEL DATA OUTPUT: Available with Printer Interface, HP 10533A.

**ACCESSORIES AVAILABLE:**  
DIGITAL RECORDER INTERFACE: Model 10533A, \$150.00.  
SERVICE SUPPORT PACKAGE: Contains an interface card and 4 diagnostic cards for easy troubleshooting of the 5300A, Model 10548A, \$90.00.  
RACK MOUNT KIT: 10573A single, 10574A double, Price \$35.00.  
DIMENSIONS (with plug-on module): Height, 3½ in. (89 mm), width 6¼ in. (160 mm), depth, 9¾ in. (248 mm).  
**PRICE: \$395.00**

### HP Model 5301A Frequency Counter

**INPUT CHANNEL**  
RANGE: 10 Hz to 10 MHz.  
SENSITIVITY (min): 25 mV rms sine wave 50 Hz to 1 MHz, 50 mV rms sine wave 10 Hz to 10 MHz, 150 mV p-p pulse at minimum pulse width, 50 ns. Sensitivity can be varied continuously up to 2.5 V rms by adjusting the SENSITIVITY control.  
IMPEDANCE: 1 MΩ shunted by less than 30 pF.  
TRIGGER LEVEL: Selectable positive, negative, or zero volts for optimum triggering from sinusoidal inputs or pulses.

**FREQUENCY MEASUREMENT**  
RANGE: 10 Hz to 10 MHz.  
GATE TIMES: Manually selected 0.1, 1, 10 seconds or AUTO.

**OPEN/CLOSE (Totalizing)**  
RANGE: 10 MHz max.  
EXTERNAL GATE: Gate signal via front-panel BNC controls gate time by contact closure to ground or TTL low level.  
**PRICE: \$125.00**

### HP Model 5302A Universal Counter

**INPUT CHANNELS A AND B**  
SENSITIVITY (min): 25 mV rms sine wave 50 Hz to 1 MHz, 50 mV rms sine wave 10 Hz to 10 MHz, 100 mV rms sine wave at 50 MHz, 150 mV p-p pulse at minimum pulse width, 50 ns. Sensitivity can be varied continuously up to 2.5 V rms by adjusting the SENSITIVITY control.  
IMPEDANCE: 1 MΩ shunted by less than 30 pF.  
TRIGGER LEVEL: Selectable positive, negative, or zero volts.

**FREQUENCY**  
RANGE: Channel A: 10 Hz to 50 MHz, prescaled by 10.  
Channel B: 10 Hz to 10 MHz.  
GATE TIMES: Manually selected 0.1, 1, 10 seconds or AUTO.

**TIME INTERVAL**  
RANGE: 100 ns to 1000 seconds.  
RESOLUTION: 100 ns to 1 ms in decade steps.

**PERIOD**  
RANGE: 10 Hz to 1 MHz.  
RESOLUTION: 100 ns to 1 ms in decade steps.

**PERIOD AVERAGE**  
RANGE: 10 Hz to 1 MHz.  
PERIODS AVERAGED: 1 to 10<sup>3</sup> automatically selected.  
FREQUENCY COUNTED: 10 MHz.

**RATIO**  
DISPLAY: F<sub>B</sub>/F<sub>A</sub> times multiplier (N). N=10 to 10<sup>7</sup>, selectable in decade steps.  
RANGE: Channel A: 10 Hz to 1 MHz.  
Channel B: 10 Hz to 10 MHz.

**OPEN/CLOSE (Totalizing)**  
RANGE: 10 MHz max.  
**PRICE: \$250.00**

### HP Model 5303A Frequency Counter

**INPUT CHANNEL A**  
RANGE: dc to 500 MHz, prescaled by 100.  
dc to 50 MHz, prescaled by 10.  
SENSITIVITY (min): 100 mV rms sine wave.  
IMPEDANCE: 50Ω.  
OVERLOAD PROTECTION: 5 V rms.

**INPUT CHANNEL B**  
RANGE: 10 Hz to 50 MHz, prescaled by 10.  
10 Hz to 10 MHz, direct.  
SENSITIVITY (min): 50 mV rms sine wave 20 Hz to 10 MHz, 100 mV rms sine wave 10 Hz to 50 MHz, 150 mV p-p pulse at minimum pulse width, 20 ns (70 ns on 10 MHz range). Sensitivity can be varied continuously up to 2.5 V × attenuator setting.  
ATTENUATOR: ×1 or ×25.  
IMPEDANCE: 1 MΩ shunted by less than 40 pF.  
TRIGGER LEVEL: Selectable positive, negative, or zero volts.

**FREQUENCY MEASUREMENT**  
GATE TIMES: 0.1, 1, or 10 seconds.  
**PRICE: \$750.00**

### HP Model 5304A Timer/Counter

**INPUT CHANNELS A AND B**  
RANGE: dc coupled; 0 to 10 MHz.  
ac coupled; 100 Hz to 10 MHz.  
SENSITIVITY (min): 25 mV rms sine wave to 1 MHz, 50 mV rms sine wave to 10 MHz, 150 mV p-p pulse at minimum pulse width, 40 ns. Sensitivity can be decreased by 10 or 100 times using ATTENUATOR switch.  
IMPEDANCE: 1 MΩ shunted by less than 30 pF.  
TRIGGER LEVEL: PRESET position centers triggering about 0 volts, or continuously variable over the range of -1 V to +1 V times attenuator setting.  
SLOPE: Independent selection of triggering on positive or negative slope.

**TIME INTERVAL**  
RANGE: 500 ns to 10<sup>4</sup> s.  
RESOLUTION: 100 ns to 10 ms in decade steps.  
TIME INTERVAL HOLDOFF: Front-panel concentric knob inserts variable delay of approximately 100 μs to 100 ms between START (Channel A) and enabling of STOP (Channel B); may be disabled. Electrical inputs during delay time are ignored.

**PERIOD AVERAGE**  
RANGE: 10 Hz to 1 MHz.  
PERIODS AVERAGED: 1 to 10<sup>3</sup> automatically selected.  
FREQUENCY COUNTED: 10 MHz.

**FREQUENCY**  
RANGE: 0 to 10 MHz.  
GATE TIMES: Manually selected 0.1, 1, 10 seconds or AUTO.

**OPEN/CLOSE (Totalizing)**  
RANGE: 10 MHz max.  
**PRICE: \$300.00**

### HP Model 5310A Battery Pack

**BATTERY CAPACITY:** 48 watt-hours, nominal. Typically 4 to 8 hours continuous operation depending on snap-on module power requirements.

**RECHARGING TIME:** 18 hours from minimum level (indicated by Low Voltage Indicator) to full charge.

**BATTERY VOLTAGE:** 12 V dc.

**LOW VOLTAGE INDICATOR:** Solid state warning light begins to glow at approximately 90% discharge.

**LINE FAILURE PROTECTION:** Allows instrument to be operated in LINE position with automatic switch-over to battery power if line voltage fails.

**OPERATING TEMPERATURE:** 0° to 50°C.

**POWER REQUIREMENTS:** Charging power via 5300A mainframe, nominal 7.5 watts.


**WEIGHT:** Net, 5 lb (2.3 kg).

**DIMENSIONS:** Battery pack plugs between 5300A mainframe and plug-on module. Increases height of instrument by 1.5 in (38.4 mm).

**PRICE: \$175.00**  
**MANUFACTURING DIVISION: SANTA CLARA DIVISION**  
5301 Stevens Creek Boulevard  
Santa Clara, California 95050

### Acknowledgments

The 5300 family was very much a team effort. Lewis Masters was responsible for the 5301A and 5302A modules. Ron Freimuth designed the 5303A in addition to creating the power supplies and the battery pack. The 5304A was the work of Tom Mingle who also designed the control IC. The mechanical design of the battery pack was contributed by Bill Anson. We would also like to thank Steve Combs, who gave us the 5301A prototype last summer, and Iton Wang for his IC support.

Of the many others who contributed their wisdom, knowledge and hard work we would particularly like to acknowledge the help of Dexter Hartke, Roy Ingham, Dave Johnstone and Joe Elston. 

### References

1. I. T. Band, H. J. Jekat, and J. B. Folsom, 'Three new technologies converge in high-performance instruments,' *Electronics*, April 26, 1971.
2. M. Brooksby, R. Pering, and R. Smith, 'Fast logic extends range of high-frequency counters,' *Electronics*, December 7, 1970.



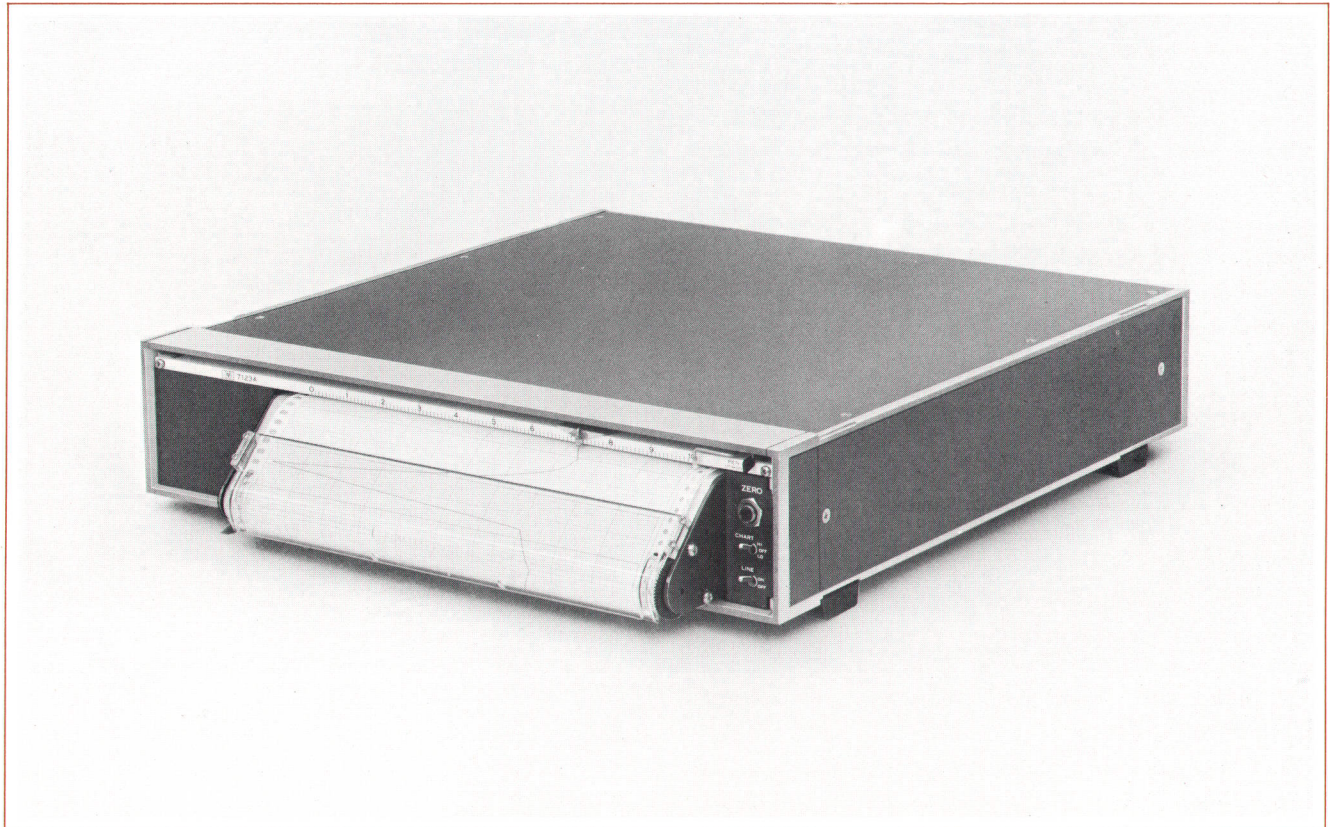
# An Almost All Solid-State Strip-Chart Recorder

*Linear motor pen drive replaces complex servo system with only one moving part.*

By Charles K. Michener

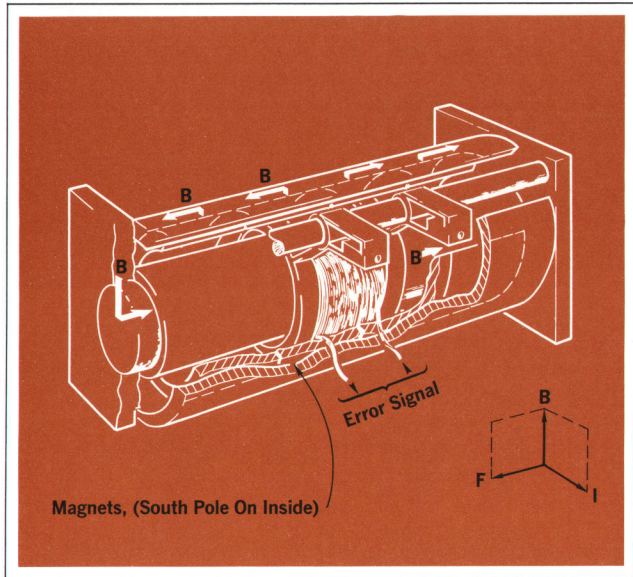
ADAPTING A LINEAR MOTOR to a small strip-chart recorder has resulted in a family of low-silhouette recorders for dedicated applications. These new Hewlett-Packard Model 7123A/B and 7143A/B Strip Chart Recorders, Fig. 1, are only 3½ inches high. Small size and high reliability is achieved largely because the linear motor

has only one moving part — the slider/pen assembly is the motor armature which slides back and forth over the length of the fixed cylindrical stator. This is similar to the mechanism of electromagnetic loud speakers and solenoids, except that the armature travel is much greater. The Model 7123A/B uses chart paper with a



**Fig. 1.** This new Hewlett-Packard Model 7123A/B Strip Chart Recorder has been developed specifically for dedicated applications. The linear servo motor has only one moving part and has high reliability.

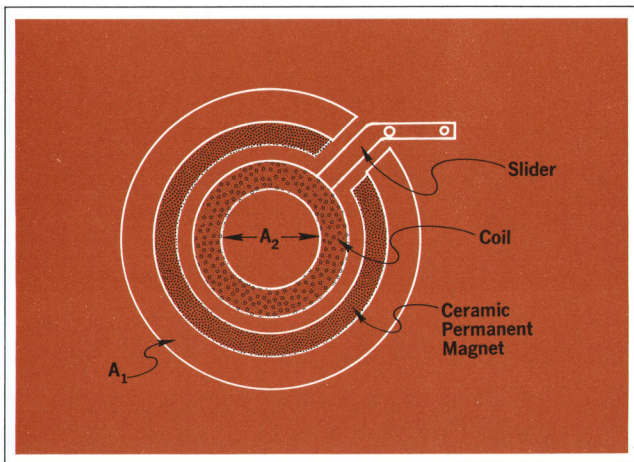




**Fig. 2.** Construction of the Hewlett-Packard linear motor. The linear motor positions a wiper on a potentiometer made of conductive epoxy film. The resulting position signal is compared to an applied input signal. The difference voltage between these signals is amplified and applied to drive the bobbin to reduce the error signal to a minimum.

10-inch wide grid; the Model 7143A/B takes paper with a 5-inch wide grid.

The entire radial field of the motor is produced by a permanent magnet. Power consumption is lower than ac servo systems, and there is almost no internal temperature rise. Also, the motor can be driven off scale continuously with no noise or damage to the recorder. Some conventional systems need either complex off-scale power reduction switches or expensive and noisy slip clutches to prevent overheating the motor.

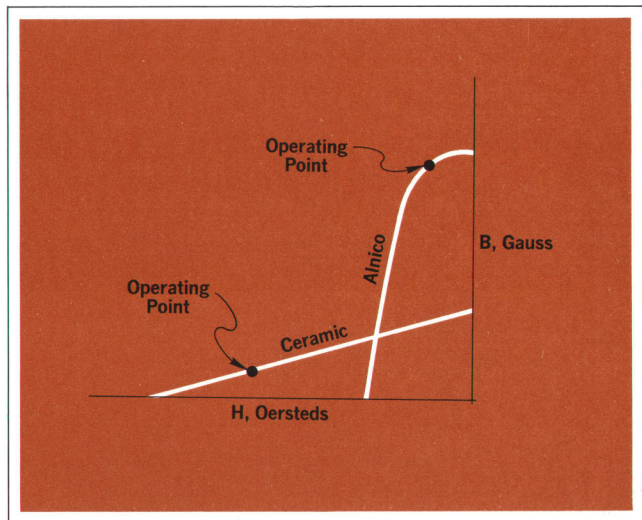


**Fig. 3.** Cross-section of the linear motor. Optimum diameters and cross sections were computer calculated.

### Linear Motor Design

The linear motor, Fig. 2, has a radial permanent magnet field ( $B$ ) that interacts with a tangential current ( $I$ ) producing an axial force ( $F$ ). Reversing the current reverses the force. In this configuration, the linear motor may be considered a large amplitude (10 inches), low frequency (2 Hz) woofer. With a field of 1000 gauss, a coil of 200 turns with a circumference of  $5\frac{1}{2}$  inches, a coil current of 2 amps produces 1.2 pounds of axial force ( $F = BNIL$ ). Bobbins of the 5 and 10 inch recorders are wound differently to assure similar dynamic performance.

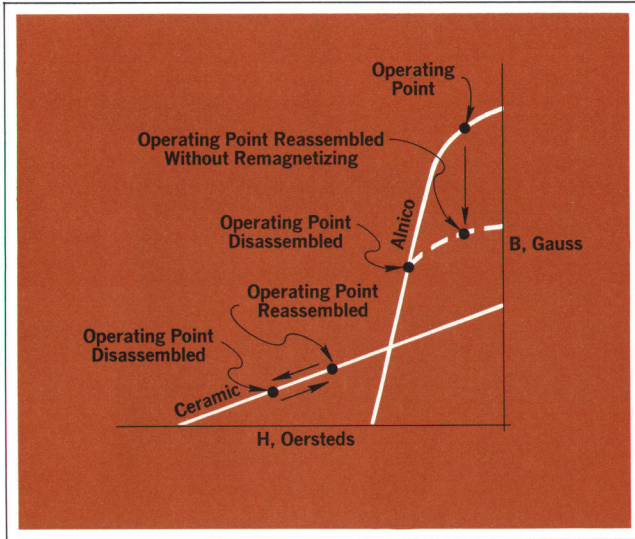
Computer design was used to get the maximum axial force for the best motor geometry within the size limits of the recorder. Magnet diameter and thickness for a given air gap were computed for the highest force. Iron cross-section areas  $A_1$  and  $A_2$  (Fig. 3) were made equal since both areas must conduct the same magnetic flux. The annular gap between  $A_1$  and  $A_2$  contains the ceramic permanent magnet and the coil with sufficient clearance for free coil travel. The relative areas of these four sections were calculated to provide maximum  $B_{pm}$  without saturating the iron at the ends of the linear motor. Thus, the motor has the highest permanent magnet field with the lowest possible servo amplifier power required.



**Fig. 4.** Magnetization curves and operating points of alnico and ceramic magnetic material. Conventional dc motors using alnico have small air gaps, small magnet areas and thick magnets. The linear motor has a large air gap, large magnetic area and thin magnets.

Ceramic permanent magnet material, rather than alnico, is used because it has a higher magnetic coercive force. It is better adapted to a thin-wall, large magnetic gap and large area design, Fig. 4. Also it has a nearly





**Fig. 5.** What happens when a magnetic assembly is disassembled then reassembled. Operating point of alnico drops, while the operating point of a ceramic magnet assembly is the same when reassembled; remagnetizing is unnecessary.

linear B-H demagnetization curve. Magnetized pieces can be disassembled and reassembled without requiring remagnetization of the assembled motor, Fig. 5. Finally, expensive materials such as cobalt and nickel are not used.

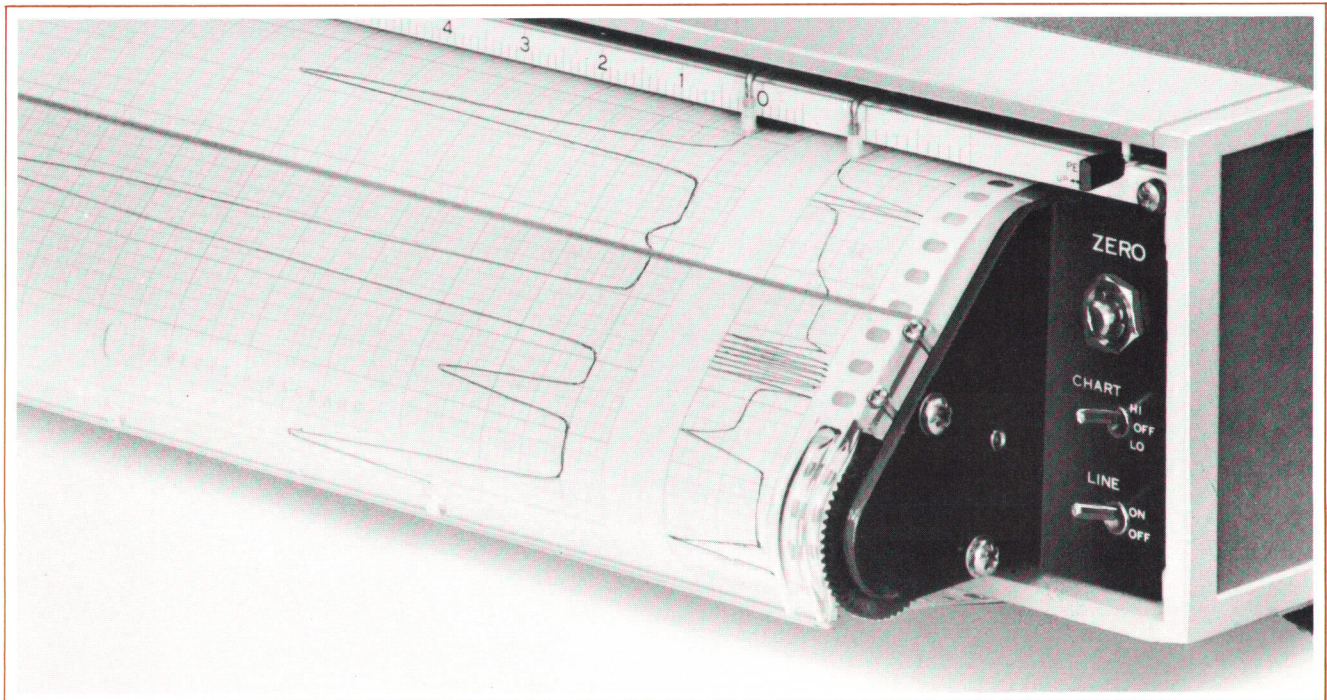
### Electronic Integrator

An easy way to record the areas under peaks of recorded curves is to record the integral of the main pen signal. A second motor slider/pen assembly can be installed on the Model 7123A/B. It shares the slider rod and magnetic circuit of the main pen assembly. The main pen signal is integrated and recorded by the integrator pen on the grid at the right side of the chart paper. Fig. 6. The distance traversed by the integrator pen is related to the area under the baseline point. A movable front scale tab sets the baseline point. Accuracy of the electronic integrator is  $\pm 0.2\%$  at  $20^\circ$  to  $30^\circ\text{C}$ .

### Writing System

The dynamic range of a capillary ink writing system (ratio of fastest pen speed to the slowest) depends upon pen tip geometry, ink viscosity and ink pressure. Writing systems with good high speed writing characteristics (no skipping) may have poor low-speed characteristics, such as ink bleeding. Good writing characteristics over the entire dynamic range of the Models 7123A/7143A recorders are achieved with a new ink pump. It is designed to use ink inertia and bobbin acceleration to maintain uniform ink pressure from the highest to the lowest pen speeds.

Electric writing is available as an option.



**Fig. 6.** An all-electronic integrator used for measuring the areas under the main trace is an option with the Model 7123A/B recorders. Its separate pen shares the slider rod and magnetic circuit of the linear motor with the main pen assembly.




## Chart Drive

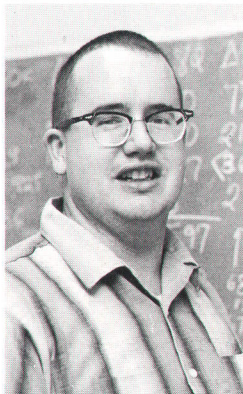
The basic chart drive for the Models 7123A/B and 7143A/B recorders is single speed, synchronous with line frequency. A number of gear reductions are available for speeds from 6 inches per minute to 1 inch per hour.

An optional multi-speed chart drive is also available. Pulses from either an external or internal source are amplified and drive a stepper motor. The internally generated pulses are provided by counting down from line frequency. The drive, then, is synchronous with line frequency. With external pulses, the data can be plotted against a variable other than time, such as distance, weight or fluid flow.

## Acknowledgments

I would like to acknowledge the valuable contributions made by the following: Jim Follansbee for the mainframe and preamplifier electrical design; Steve White for the mainframe and integrator electrical design; Lloyd Yabsley for the product and industrial design; Hendrick Swart for preamplifier and integrator product design; Marv Underhill for his work on the ink writing systems; and Tom Barker for his work on the chart drive. 

### Charles K. Michener



Chuck Michener received both his Bachelor of Science and Master of Science Degrees in Mechanical Engineering from the California Institute of Technology. He joined the San Diego Division of Hewlett-Packard Company after receiving his M.S. in 1966. Since then Chuck has been involved in mechanical design of recorder servo drives, including the linear motor. He was project leader for the development of the 7123A/7143A linear motor Strip Chart Recorders.

## SPECIFICATIONS

### HP Model 7123A/B and 7143A/B Strip Chart Recorders

**INPUT RANGES:** Single span, 1 mV–100 V (specified by option).  
**TYPE OF INPUT:** Single ended, floating.  
**INPUT RESISTANCE:** 1 M $\Omega$  constant on all spans.  
**MAXIMUM ALLOWABLE SOURCE RESISTANCE (R<sub>s</sub>):** 10 k $\Omega$  (unrestricted for spans below 1 V).  
**NORMAL MODE REJECTION (at line frequency):** >40 dB.  
**COMMON MODE REJECTION:** 100 dB at dc and 80 dB at line frequency.  
**RESPONSE TIME (R<sub>s</sub>  $\leq$  10 k $\Omega$ ):** <1/3 s for 7123A/B; <1/4 s for 7143A/B (<1/2 s for spans below 1 V).  
**OVERSHOOT:** <1%.  
**ACCURACY:**  $\pm 0.2\%$  full scale.  
**ZERO DRIFT:**  $< \pm 0.005\%/^{\circ}\text{C}$ .  
**LINEARITY (terminal based):**  $\pm 0.1\%$  full scale.  
**REFERENCE STABILITY:**  $\pm 0.002\%/^{\circ}\text{C}$ .  
**CHART SPEEDS:** Speed determined by option choice.  
**CHART SPEED ACCURACY:** Synchronous with line frequency.  
**ZERO SET:** Left hand, adjustable  $\pm 1$  full scale (right hand optional).  
**ENVIRONMENTAL (operating):** 0° to 55°C, <95% RH (25° to 40°C).  
**WRITING MECHANISM:** Servo actuated ink pen (electric writing optional).  
**GRID WIDTH:** 10 in or 25 cm for 7123A/B; 5 in or 12 cm for 7143A/B.  
**PEN LIFT:** Manual (electric optional).  
**POWER** — 7123A: 115/230 V  $\pm 10\%$ , 60 Hz, 30 VA.  
— 7123B: 115/230 V  $\pm 10\%$ , 50 Hz, 30 VA.  
— 7143A: 115/230 V  $\pm 10\%$ , 60 Hz, 30 VA.  
— 7143B: 115/230 V  $\pm 10\%$ , 50 Hz, 30 VA.  
**PRICE:** Option choice for both span and chart speed must be specified:  
7123A (60 Hz) **\$750.00**  
7123B (50 Hz) **\$750.00**  
7143A (60 Hz) **\$695.00**  
7143B (50 Hz) **\$695.00**  
OEM discounts available.

### Electronic Chart Integrator Option 035

**ACCURACY:**  $\pm 0.2\%$  of full scale count rate (20°C to 30°C).  
 $\pm 0.4\%$  of full scale count rate (0°C to 55°C).  
**LINEARITY:**  $\pm 0.2\%$  of full scale count rate.  
**READABILITY:**  $\pm 1$  count.  
**RESPONSE TIME:** Integration continuous, zero time lag between main pen motion and Integrator pen response.  
**BASELINE:** Front panel adjustable over entire chart width.  
**ENVIRONMENTAL (Operating):** 0°C to 55°C, 95% RH (25°C to 40°C).  
**FULL SCALE COUNT RATE:** 6,000 counts per minute (standard).  
**ZERO DRIFT:**  $\pm 12$  counts per minute.  
**TYPE:** All electronic, the Integrator records + and - areas formed between main pen's trace and baseline set point.  
**WRITING MECHANISM:** Servo actuated ink pen.  
**WRITING WIDTH:** Integral recorded on 1 inch grid, right side of chart. Main signal recorded on 8.0 inch grid (10 major divisions).  
**PEN LIFT:** Manual (remote optional), common with main pen.  
**PRICE:** Option 035 (factory installed in 7123A/B), add **\$750.00**. OEM Discounts available.  
**MANUFACTURING DIVISION:** SAN DIEGO DIVISION  
16399 W. Bernardo Drive  
San Diego, California 92127

## HEWLETT-PACKARD JOURNAL AUGUST 1971 Volume 22 • Number 12

FROM THE LABORATORIES OF HEWLETT-PACKARD COMPANY 1501 PAGE MILL ROAD, PALO ALTO, CALIFORNIA 94304 U.S.A.  
Hewlett-Packard S.A. 1217 Meyrin - Geneva, Switzerland • Yokogawa-Hewlett-Packard Ltd., Shibuya-Ku, Tokyo 151 Japan

Editor: R. H. Snyder Editorial Board: R. P. Dolan, H. L. Roberts, L. D. Shergalis Art Director: Arvid A. Danielson Assistant: Maridel Jordan